



TECHNICAL DATASHEET

TAB POLAR S45J

ORDER INFORMATION

TAB ID
246145

Short Code
S45J

DIN Marking
54520 SMF

EAN Code
3838807030312

Quantity per EU/CNT pallet
96/128 pcs

TECHNOLOGY

Primary Function
Engine Start

Battery Technology
Flooded

Grid Type (pos/neg)
Expanded/Concasted

Grid Alloy (pos/neg)
Ca/Ca

Separator
PE

Electrolyte (g/cm³)
1,28

TECHNICAL INFORMATION

Voltage (V)
12

Capacity C20 (Ah)
45

CCA -18°C EN (A)
360

RC (min)
71

LxWxH (mm)
196x134x202/223

Total Weight (kg)
10.6

BOX DESIGN

Box Type
B19

Cover Type
SMF

Colour
Black

Layout
0

BHD
B01

Terminal
1

DRAWING

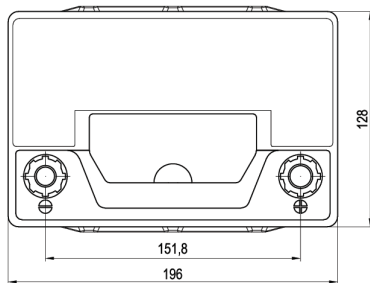
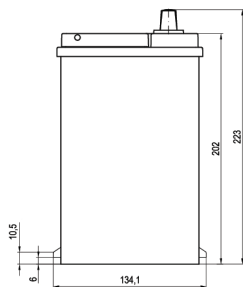
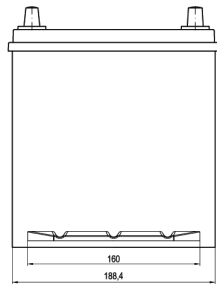

BHD

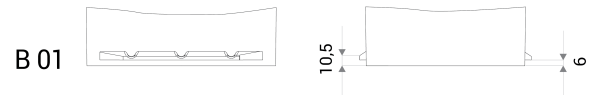

LAYOUT



TERMINAL

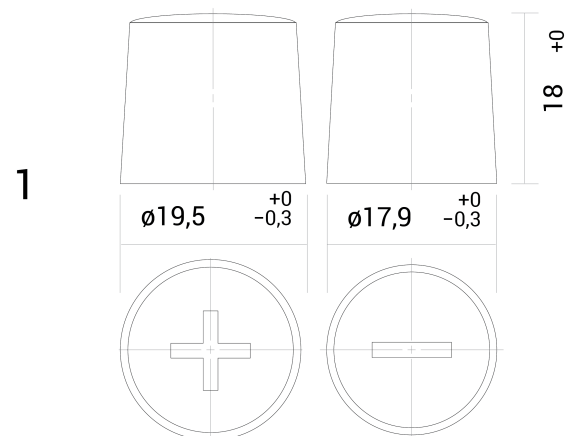

TECHNICAL DATASHEET

TAB POLAR S45J