



# TECHNICAL DATASHEET

## TAB AGM STOP&GO AG105

### ORDER INFORMATION

TAB ID  
**213105**

Short Code  
**AG105**

DIN Marking  
**L6 AGM**

EAN Code  
**3838807039575**

Quantity per EU/CNT pallet  
**36/60 pcs**

### TECHNOLOGY

Primary Function  
**Advanced Start/Stop Functionality**

Battery Technology  
**AGM - Absorbent Glass Mat**

Grid Type (pos/neg)  
**Casted/Concasted**

Grid Alloy (pos/neg)  
**Ca/Ca**

Separator  
**GM**

Electrolyte (g/cm<sup>3</sup>)  
**1,3**

### TECHNICAL INFORMATION

Voltage (V)  
**12**

Capacity C20 (Ah)  
**105**

CCA -18°C EN (A)  
**950**

RC (min)  
**206**

LxWxH (mm)  
**394x175x190**

Total Weight (kg)  
**29.2**

### BOX DESIGN

Box Type  
**L6**

Cover Type  
**Sealed**

Colour  
**Black**

Layout  
**0**

BHD  
**B13**

Terminal  
**1**

## DRAWING

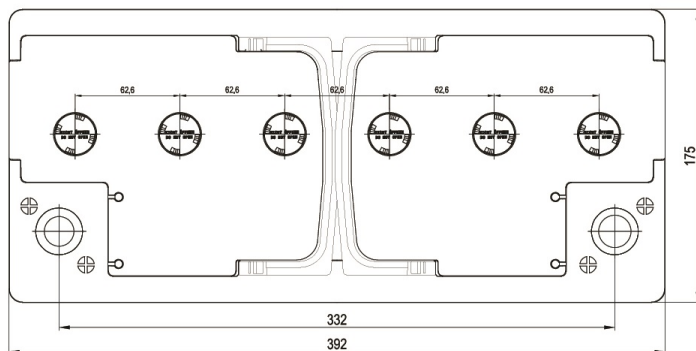
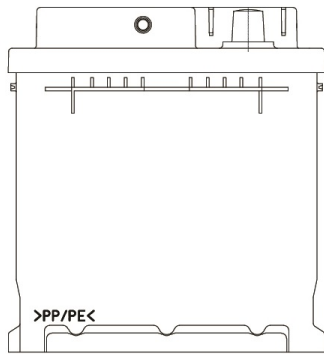
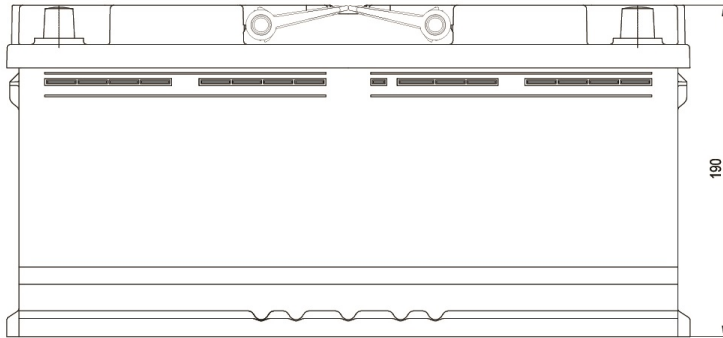

## BHD



## LAYOUT



## TERMINAL



## TECHNICAL DATASHEET

# TAB AGM STOP&GO AG105