



TECHNICAL DATASHEET

TAB MAGIC TRUCK TM18

ORDER INFORMATION

TAB ID
347612

Short Code
TM18

DIN Marking
68032 SMF

EAN Code
3838807040434

Quantity per EU/CNT pallet
21/28 pcs

TECHNOLOGY

Primary Function
Engine Start

Battery Technology
Flooded

Grid Type (pos/neg)
Casted/Concasted

Grid Alloy (pos/neg)
Ca/Ca

Separator
PE

Electrolyte (g/cm³)
1,28

TECHNICAL INFORMATION

Voltage (V)
12

Capacity C20 (Ah)
180

CCA -18°C EN (A)
1100

RC (min)
361

LxWxH (mm)
513x222x194/221

Total Weight (kg)
43.1

BOX DESIGN

Box Type
B

Cover Type
SMF

Colour
Black

Layout
3

BHD
B0

Terminal
1

DRAWING

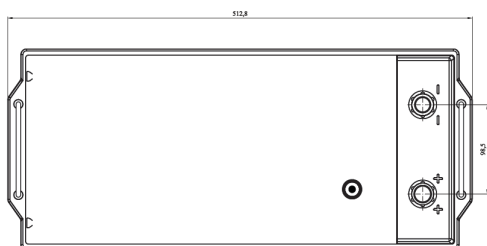
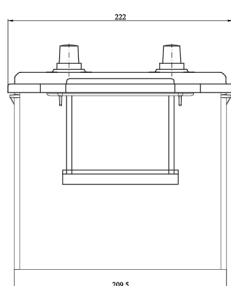
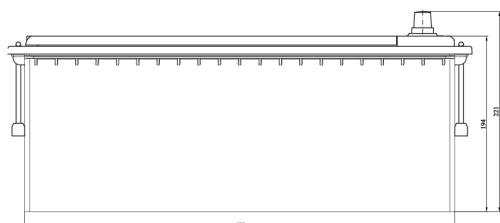

BHD



LAYOUT

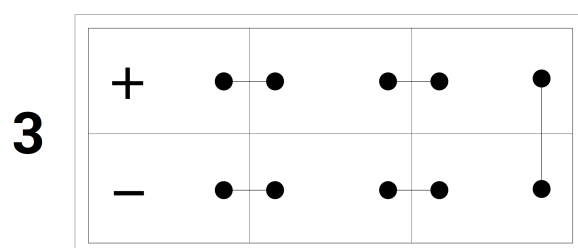

TERMINAL

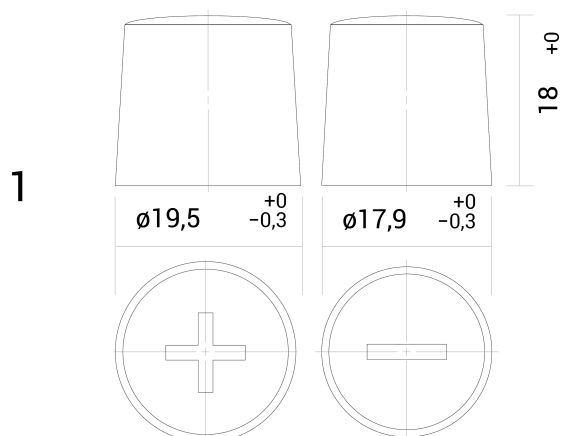

TECHNICAL DATASHEET

TAB MAGIC TRUCK TM18